

Translation



# Operating Instructions High-Z Standard-Series

S-400 ▪ S-720 ▪ S-1000

[www.cnc-router.com](http://www.cnc-router.com)



Status: 14.03.2015



## High-Z Standard-Series

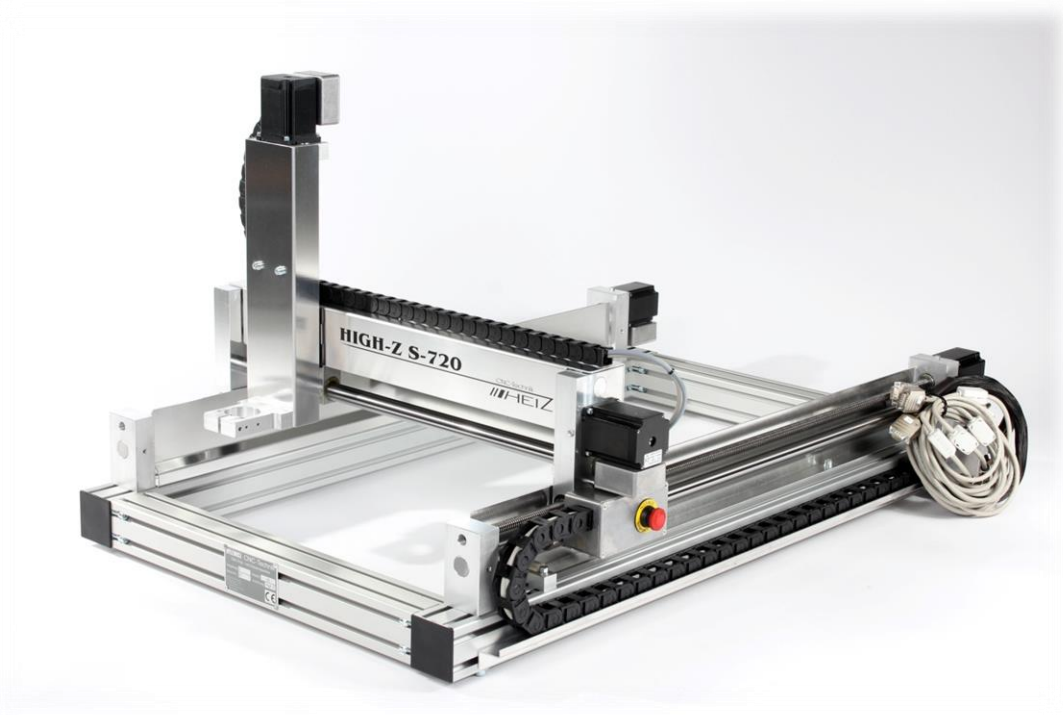

### Short description

The machine includes the complete mechanics for three-dimensional movement. The linear carriage-movement takes place via threaded spindles, powered by step motors. Two drives are used on the x-axis. The activation of the step motors, in order to operate every single axis, is done by using further interfaces. This operating description will show you how to install, operate and service a CNC-portal system.

## Contents

<b>1</b>	<b>GENERAL</b> .....	<b>7</b>
1.1	Symbol description.....	7
1.2	Limitation of Liability.....	8
1.3	Copyright.....	8
<b>2</b>	<b>SAFETY</b> .....	<b>9</b>
2.1	Intended use.....	9
2.2	Fundamental dangers.....	10
2.2.1	Hazards from electrical power.....	10
2.2.2	Dangers by mechanics.....	11
2.2.3	Dangers by high or very low temperatures.....	13
2.2.4	Risk of fire.....	13
2.2.5	Radiation hazards.....	14
2.2.6	Hazards of chemicals.....	14
2.2.7	General work-related dangers.....	16
2.3	Responsibility of the operator.....	17
2.4	Staff requirements.....	18
2.4.1	Qualification.....	18
2.4.2	Instruction.....	19
2.5	Personal protective equipment.....	19
2.6	Safety installations.....	20
2.6.1	Description of the installed safety installations.....	21
2.6.2	Safety installations, which have to be updated by the owning operator.....	22
2.7	Behaviour in case of fire or accidents.....	22
2.8	Environmental protection.....	23
2.9	Signage.....	23
2.9.1	Mandatory signs.....	24
2.9.2	Prohibition signs.....	24
2.9.3	Warnings.....	25
2.9.4	Fire protection signs.....	26
2.9.5	Exit signs.....	27
<b>3</b>	<b>TECHNICAL SPECIFICATIONS</b> .....	<b>28</b>
3.1	General information.....	28
3.2	Power values.....	30

---

<b>3.3</b>	<b>Operating conditions</b> .....	<b>30</b>
<b>3.4</b>	<b>Working materials</b> .....	<b>30</b>
<b>3.5</b>	<b>Emissions</b> .....	<b>30</b>
<b>3.6</b>	<b>Type plate</b> .....	<b>31</b>
<b>4</b>	<b>STRUCTURE AND FUNCTIONS</b> .....	<b>32</b>
<b>4.1</b>	<b>Overview</b> .....	<b>32</b>
<b>4.2</b>	<b>Brief description of the application range</b> .....	<b>33</b>
<b>4.3</b>	<b>Module Description</b> .....	<b>34</b>
4.3.1	Z-axis with carriage .....	34
4.3.2	Y-axis with carriage.....	35
4.3.3	X-axis with carriage.....	36
4.3.4	Tool holder .....	37
<b>4.4</b>	<b>Controls</b> .....	<b>37</b>
<b>4.5</b>	<b>Connections</b> ..... Fehler! Textmarke nicht definiert.	
4.5.1	Control signals (ST).....	39
	Motor connector (X1,X2,Y,Z) .....	39
4.5.2	MiniXLR pin socket (Pin15) .....	40
<b>4.6</b>	<b>Work and danger areas</b> .....	<b>41</b>
4.6.1	Working area .....	41
4.6.2	Danger zone .....	41
<b>5</b>	<b>TRANSPORT, PACKAGING AND STORAGE</b> .....	<b>42</b>
<b>5.1</b>	<b>Safety instructions for transport</b> .....	<b>42</b>
<b>5.2</b>	<b>Transport inspections</b> .....	<b>43</b>
<b>5.3</b>	<b>Packaging</b> .....	<b>44</b>
<b>5.4</b>	<b>Symbols on packaging</b> .....	<b>45</b>
<b>5.5</b>	<b>Transport</b> .....	<b>45</b>
<b>5.6</b>	<b>Storage</b> .....	<b>47</b>
<b>6</b>	<b>INSTALLATION AND COMMISSIONING</b> .....	<b>48</b>
<b>6.1</b>	<b>Safety instructions for the installation and commissioning</b> .....	<b>48</b>
<b>6.2</b>	<b>Preparations</b> .....	<b>49</b>
6.2.1	Install machine.....	49
6.2.2	Install worktop .....	50
<b>6.3</b>	<b>Installation</b> .....	<b>50</b>

---

6.3.1	Connecting the computer.....	50
6.3.2	Connecting the stepper motor and control cable .....	51
6.3.3	Installing Accessories .....	52
<b>6.4</b>	<b>Initial start-up.....</b>	<b>53</b>
<b>7</b>	<b>OPERATION.....</b>	<b>54</b>
<b>7.1</b>	<b>Safety guidelines for operation.....</b>	<b>54</b>
<b>7.2</b>	<b>Operations before usage .....</b>	<b>54</b>
<b>7.3</b>	<b>Switching on.....</b>	<b>54</b>
<b>7.4</b>	<b>Activities during operation.....</b>	<b>55</b>
7.4.1	Operating machine.....	55
7.4.2	Change tool.....	58
<b>7.5</b>	<b>Switching off .....</b>	<b>58</b>
<b>7.6</b>	<b>Activities after use .....</b>	<b>59</b>
<b>7.7</b>	<b>Emergency Shutdown .....</b>	<b>59</b>
<b>8</b>	<b>MAINTENANCE .....</b>	<b>60</b>
<b>8.1</b>	<b>Safety Instructions for maintenance.....</b>	<b>60</b>
<b>8.2</b>	<b>Spare parts.....</b>	<b>61</b>
<b>8.3</b>	<b>Maintenance Schedule .....</b>	<b>62</b>
<b>8.4</b>	<b>Maintenance.....</b>	<b>63</b>
8.4.1	Cleansing of the machine .....	63
8.4.2	Lubricate machine .....	64
<b>8.5</b>	<b>Measures after maintenance .....</b>	<b>68</b>
<b>9</b>	<b>FAILURES .....</b>	<b>69</b>
<b>9.1</b>	<b>Cautions for Troubleshooting .....</b>	<b>69</b>
<b>9.2</b>	<b>Diagnosis Chart .....</b>	<b>71</b>
<b>9.3</b>	<b>Problem resolution .....</b>	<b>73</b>
9.3.1	Cancel the emergency stop .....	73
9.3.2	Check axes for perpendicularity .....	73
9.3.3	Description of process for aligning the machine with respect to perpendicularity .....	74
<b>9.4</b>	<b>Commissioning after fault has been rectified .....</b>	<b>74</b>
<b>10</b>	<b>DISMANTLING AND DISPOSAL .....</b>	<b>75</b>
<b>10.1</b>	<b>Safety regulations for the disassembling and disposal .....</b>	<b>75</b>

---

<b>10.2</b>	<b>Disassembling .....</b>	<b>75</b>
<b>10.3</b>	<b>Disposal .....</b>	<b>76</b>
<b>11</b>	<b>APPENDIX .....</b>	<b>77</b>
<b>11.1</b>	<b>Accessories .....</b>	<b>77</b>
<b>12</b>	<b>CUSTOMER SERVICE .....</b>	<b>78</b>

## 1 General

This instruction provides guidelines which enable a safe and efficient handling of the machine. The manual is an integral part of the machine and must be kept in the immediate vicinity of the machine and accessible at any time for the personnel.

Before starting all tasks, personnel must carefully read and understand these instructions.

Adherence to all the specified safety instructions and instructions for actions in this operating manual is a fundamental requirement for working safely.





Furthermore, the local accident prevention regulations and general safety conditions for the application of the machine are also applicable.

Illustrations in this manual are intended to facilitate basic understanding, and may differ from the actual design.



Further guidelines regarding built-in components are found in the appendix of this description.

### 1.1 Symbol description

**Safety instructions are designated by symbols. In addition, there is always a signal word heading the information indicating the severity of the danger or hazard that may be encountered.**

	<p><b>HINT:</b> Indicates a potentially hazardous situation which, if not avoided, could result in property damage or environmental contamination.</p>
	<p><b>WARNING:</b> This signal word and symbol indicates a risk which can lead to severe injury or even death, if not avoided.</p>
	<p><b>ATTENTION:</b> This signal word and symbol indicates a risk which can lead to small injuries, if not avoided.</p>
	<p><b>Danger:</b> This signal word and symbol indicates a risk which can lead to severe injury or even death, if not avoided.</p>
	<p><b>Prohibition for people with pacemakers</b> This sign stands for activities involving risks for people with pacemakers. These areas are prohibited for people with pacemakers!!</p>



	<b>Warning of hazardous electrical voltage</b> This sign stands for activities on all components carrying live voltage.
	<b>Danger due to hot surface</b> This sign stands for activities involving contact with hot objects.

## 1.2 Limitation of Liability

All data and notes in these instructions were prepared with consideration to the statutory standards and regulations, the present state of technology, as well as our many years of knowledge and experience.

Under the following circumstances the manufacturer will not assume any liability:

- Non-compliance with these instructions
- Used other than for the intended purpose
- Unauthorized or unapproved personnel
- Unauthorised rebuilds or modifications
- Unauthorized technical changes
- The use of unauthorized replacement parts or non-original accessories

The actual scope of delivery can, by special designs, deviate from the explanations and presentations given here, because of the utilization of additional order options, or because of the most recent technical changes.

The responsibilities agreed in the delivery contract, the General Terms and Conditions as well as the delivery conditions of the manufacturer and the statutory regulations valued at the time of conclusion of the contract are effective.

## 1.3 Copyright

The contents of this instruction are copyrighted. It is to be used for the purpose of operating the machine, only. Any other use without a written permission is forbidden.





## 2 Safety

This section gives an overview of all important safety aspects for optimum protection of the personnel, as well as for the safe and fault-free operation. Other task-based guide-lines are included in the sections regarding the individual phases of life.

### 2.1 Intended use

The CNC-Portal system is exclusively used for holding provided tools that serve to process various materials and surfaces.

The machine is meant to be built into a complete system and does not have its own control unit.

Intended use also includes compliance with instructions specified by the manufacturer concerning operation, servicing and maintenance.

Every application in excess of the intended use and/or other use, can lead to hazardous situations and is considered misuse.



**WARNING:**  
**Danger due to misuse!**

Improper use of the CNC-portal machine can cause dangerous situations.

- Operation outside the values specified in the section „Technical data“.
- Bypassing the safety devices.
- Remodelling, refitting or changing of the device or parts of it, with the intention to alter functionality or usability.
- If machining process involves flammable cooling lubricants.
- Processing light alloys such as aluminium, magnesium and titanium alloys without extraction attachments and corresponding safety measures.
- Operating the machine, although it is not in perfect condition from a technical point of view.
- Operating the machine in potentially explosive environment.

The manufacturer shall not be held liable for any and all damage due to misuse of this equipment.



## 2.2 Fundamental dangers

In following section, all residual risks are named that can still result from the machine, even when the appliance is used as intended.

In order to minimize personal injuries and property damage and avoid dangerous situations, all here mentioned safety-guidelines and those mentioned in further sections must be followed.

### 2.2.1 Hazards from electrical power

#### Electric current



**DANGER:**  
**Life Hazard through electrical shock!!**

Touching conductive parts causes a direct danger to due to electrical shock.  
Damage to the insulation or individual components can mean danger to life.

- Any work required at the electrical system may only be carried out by a qualified electrician in compliance with electro-technical regulations.
- In case of damage to the insulation, switch off the power supply immediately and have repairs carried out.
- Before starting to work on active parts of electrical systems and equipment, establish a voltage-free state throughout the duration of the work, this must take place according to the 5 following safety regulations:
  - Activation.
  - Secure it from being switched on again.
  - Determine voltage free status.
  - Earth and short circuit.
  - Provide protection by covers or barriers for any neighbouring live parts.
- Never attempt to bypass or de-activate fuses or cut-outs. When replacing fuses or circuit breakers make sure to adhere to the correct ampere rating. Keep moisture away from live parts.

### Stored charge



**Danger:**  
**Risk of death due to stored voltage!**

Electronic charges could be stored in electric components that still exist after switching off and disconnecting from power-supply. Contact with these components can lead to severe injury or even death.

- Before starting work disconnect mentioned components from power-supply. Wait 10 minutes, in order to assure that the internal capacitors discharge completely.

## 2.2.2 Dangers by mechanics

### Rotating tools



**WARNING:**  
**Risk of injury from rotating tools!**

Clamped tools such as milling spindles can lead to severe personal injury or material damage.

- Before the start of any work, ensure that all covers and protective devices are correctly installed and function correctly.
- Never touch moving tool during operating process!
- Before exchanging tools, always pull power plug of the milling motor or turn off the machine and secure against restarting.

### Axis motion

**WARNING:**  
**Risk of injury by axis motion!**

Collision by people with components of the machine (Y-bridge, Units, turntable with work piece, tools) can cause severe injuries.

- Body parts are kept away from moving components and axis limit switches.
- Do not reach into gaps between trapezoidal screws and adjacent components.
- Do not reach into gaps between unit and Y-bridge.
- Only work on the machine when it is idle.
- Only work with personal safety equipment.

#### Falling materials



**WARNING:**  
**Injuries by falling materials!**

During operation chips, tools (or parts of it) could be thrown out uncontrollably or cause severe injuries to skin and eyes.

- Wear face shield or fully closed and tight-fitting goggles, protective clothing, protective gloves and safety shoes.
- If particles enter your eyes, immediately get medical attention!

#### Unexpected start-up of the machine



**WARNING:**  
**Risk of injury caused by unexpected start-up of the machine**

The machine and the used tools can start-up unexpectedly, change their direction or stop. Limbs can get trapped.

- It must be ensured that, no body parts get in the danger zone of the machine.
- Protect working area against unintentional access.

#### Tools



**ATTENTION:**  
**Risk of injuries by negligent handling of tools!**

By handling tools negligent, lacerations and crushing injuries can be caused.

- Tools must be handled with care and used in accordance with the regulations.
- Take weight into account when transporting tools.
- Wear safety shoes and protective gloves.

#### Sharp edges and corners



**ATTENTION:**  
**Risk of injuries by sharp edges and corners!**

Sharp edges and corners can cause abrasions and cuts on your skin.

- Working near sharp edges and corners should be done with great caution.
- If in doubt wear protective gloves.



## 2.2.3 Dangers by high or very low temperatures

### Hot surfaces



**ATTENTIONS:**

**Risks by hot surfaces!**

Tools, work pieces and chips can heat up during operation. Skin contact with hot surfaces causes serious burns of the skin.

- As a matter of principle, for all tasks with tools, work pieces and chips, protective clothing and gloves must be worn.
- Before all tasks, make sure that all surfaces have cooled down to the ambient temperature.

## 2.2.4 Risk of fire

### Highly flammable materials



**ATTENTION:**

**Risk of fire by highly flammable materials!**

Organic dust produced by coal or wood or inorganic dust from magnesium, aluminium, zinc or titanium can catch fire and cause severe injuries and death.

- Do not smoke within the danger zone and the immediate vicinity. Refrain from contact with open flames or sources of ignition.
- Keep a fire extinguisher at hand in the immediate vicinity of the work area.
- Do not process light alloys such as magnesium, aluminium, zinc and titanium without an extraction system and relevant security measures.
- Suspend any work activities in case of fire. Leave the danger zone until the all clear signal is given

## 2.2.5 Radiation hazards

### Magnetic fields



**DANGER:**  
**Danger to life by magnetic fields!**

Magnetic fields of step motors can cause severe injuries or death, as well as serious damage to materials.

- Persons with pacemakers must keep away from the machine! It can effectively provoke a dysfunction of the pacemaker.
- Persons with metallic implants must not be allowed in the area of the machine. Implants can heat themselves up or be drawn-in.
- Take off all metal objects (Jewellery, watches, pens etc.) before starting maintenance operation.
- No electronica equipment is to be taken into the magnetic source area. These could get damaged.
- No storage media, credit cards etc. are to be taken into the magnetic source area. Containing data may be deleted.

## 2.2.6 Hazards of chemicals

### Cooling emulsion



**WARNING:**  
**Danger of serious damage to health by polluted cooling emulsion!**

Polluted cooling emulsion can cause inflammations when coming in contact with skin.

- Cooling emulsion must be checked at regular intervals.
- When handling with polluted cooling emulsion protective clothing and chemical-resistant safety-gloves must be worn.
- Avoid direct skin contact. Cleanse skin, especially before breaks and when finishing work.
- Eat and drink in relevant break room only!



**ATTENTION:**

**Health risks due to contact with cooling emulsion!**

Contact with cooling emulsion may lead to health risks.

- Avoid contact with your skin.
- Remove cooling emulsion from the skin immediately.
- Do not inhale the vapours.

**Oil and fat**



**ATTENTION:**

**Risk of health due contacting with oil and fat!**

Contact with oil and fat may lead to health risks.

- Avoid skin contact.
- Remove oil and fat immediately from skin.
- Do not inhale vapours.



## 2.2.7 General work-related dangers

### Noise



**ATTENTION:**  
**Risk of injury by noise!**

The noise levels occurring in the operating area may cause severe hearing damage.

- Always wear hearing protection when working.
- Only stay in the danger area when required.

### Dirt and objects lying around



**Attention:**  
**Risk of tripping by dirt and objects lying around!**

Soiling and objects left lying around are sources of slipping and stumbling and can cause considerable injuries.

- Always keep the work area clean.
- Remove any objects which are no longer required from the working area, especially those near ground.
- Designate tripping positions with yellow-black marker band.



## 2.3 Responsibility of the operator

### Operator

Operator is the person who operates the machine for commercial or economic purposes, or leaves the use / application to a third party and bears responsibility during the operation of the product for the protection of the user, the staff and third party.

### Operator obligations

The machine is used in the commercial sector. The operator of the machine is therefore subject to the legal obligations concerning occupational safety. Apart from the safety instructions given in this manual, it is necessary to meet all safety, accident prevention and environmental protection requirements applicable to the equipment's field of use and operating site.

The following principles apply in particular:

- The operating company must inform itself about the effective industrial regulations and determine additional hazards in a risk assessment that result through the special working conditions at the place of operating the machine. He must implement this in the form of operating instructions for the operation of the machine.
- During the complete usage time of the machine, the owner must check whether the operating instructions created by him correspond with the current status of the regulations and must adapt them if necessary.
- The owner must clearly regulate and specify the responsibilities for installation, operation, maintenance and cleaning
- The operator of the machine must ensure that all persons having access to it, have read and understood these instructions. In addition he must at regular intervals train the employees in how to deal with the machine and inform them about potential hazards.
- The operating company must provide the required safety equipment for the personnel and order to wear protective equipment.

Moreover, the equipment operator is responsible for ensuring that the equipment is in proper technical condition at all times.

Thus, following applies:

- The operating company must make sure that any and all maintenance intervals described in this instruction are carried out.
- The owner must arrange for all safety equipment to be checked regularly for functionality and completeness.



## 2.4 Staff requirements

### 2.4.1 Qualification

The different Tasks contained in this instruction require different qualifications auf persons that are intrusted with these tasks.



**WARNING:**

**Risks caused by insufficient qualifications of persons!**

Insufficient qualified persons cannot assess the extent to which they represent a risk handling with the machine and therefor run the risk of injuries or death for themselves and others.

- Work on or in the unit must be done only by duly qualified staff and in full compliance with the appropriate instructions and pertinent regulations...
- Keep insufficiently qualified persons away from the work area.

Only persons of whom it may be expected that they perform their work reliably are permitted as personnel. Persons whose responsiveness is affected, e.g. by drugs, alcohol or medicines are not authorized.

In this instruction all required qualifications, for the different people, with different tasks are named:

#### **Operator**

The operator was instructed by the operating company in a briefing about the tasks assigned to them and instructed about possible hazards because of improper conduct. Tasks, die which are carried out beyond the normal operation, only are allowed to be carried out by an operator if this is mentioned in this instruction and the operating company has assigned the operator expressly.

#### **Electrician**

An electrician whose technical training, skills and experience together with their knowledge of pertinent regulations and documentation means that they are capable of assessing the work to be carried out and detect and prevent any possible dangers.

An electrician is trained especially for its working environment, and knows the relevant standards and regulations.

#### **Qualified personnel**

Qualified personnel based on their professional training, know-how and experience as well as knowledge of the applicable standards and regulations is able to perform assigned work activities and to detect and to avoid possible dangers on their own.

## **Manufacturer**

Curtain maintenance work is only allowed to be carried out by authorized and skilled personnel. Other personnel is not authorised to carry out these tasks. In order to carry out this maintenance work, please call our customer service!

## **2.4.2 Instruction**

The owner must train staff regularly. For record-keeping purposes, a log of training conducted must be kept with following minimum contents:

- Date of training
- Name of trained person
- Contents of training
- Name of trainer
- Signature of trained person and trainer

## **2.5 Personal protective equipment**

Personal protective equipment prevents from impairments with respect to the safety of personnel during work.

Personnel have to wear personal protective equipment while working on the machine, which are mentioned in different sections of this instruction.

### **Description of personal protective equipment**



#### **Protective clothing**

Protective clothing is close fitting, with low resistance to tearing, with narrow sleeves and without protruding parts.



#### **Chemical resistant safety gloves**

Suitable chemical resistant safety gloves have to worn to protect your skin from aggressive chemicals.



#### **Hearing protection**

Hearing protection prevents irreversible damage to hearing.



#### **Industrial protection helmet**

Industrial protection helmet prevents from injuries by falling or suspended objects.



#### **Safety glasses**

Safety glasses prevent injuries in eyes from parts flying around or squirts of fluids.



#### **Protective gloves**

Protective gloves protect the hands from rubbing, abrasions, cuts or more profound injuries, as well as when touching hot surfaces.



#### **Protective cover**

Wear protective cove to protect long hair from being caught, wrapped up in, or drawn into moving parts.

Employees are required to wear protective covers, if their hair is longer than the extent of the shaft and its moving parts.



#### **Safety boots**

Safety shoes protect the wearer's feet against falling objects, from being crushed, slippery surfaces and being run over by vehicles.

## 2.6 Safety installations



#### **WARNING:**

#### **Malfunctioning safety installations may pose a fatal risk!!**

Malfunctioning or deactivated safety installations may cause severe injuries and even death!

- Before starting to work, check all safety installations regarding their functional efficiency and correct installation.
- Never deactivate or bypass safety equipment.
- Take care to ensure that safety installations are always accessible.

## 2.6.1 Description of the installed safety installations

### Emergency-stop-button



Figure 1: Emergency-stop-button

By pressing the emergency-stop-button (Figure 1) the machine is shut down by immediately switching off the energy supply to the machine drives. After pressing the emergency-off-button, it has to be turned to be able to turn the machine on again.



### WARNING:

#### Danger to life when unintentional switching the machine back on!

Unintentional start-up of the machine can lead to severe injuries and death.

- Before switching on the machine make sure, that the cause of the emergency-stop is eliminated and all safety installations are correctly installed and functional.
- Only unlock the emergency-stop-button (Figure 2 u. 3) when there is no risk.

### Position of emergency-stop-button

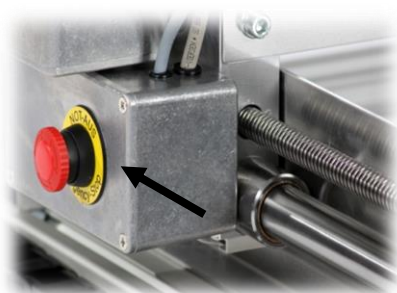

Figure 2: Emergency-stop-button on Y- bridge



Figure 3: Emergency-stop-button on step-motor controller



---

## 2.6.2 Safety installations, which have to be updated by the owning operator

### Extraction

When processing light metal alloy such as magnesium, aluminium and titanium an extraction system has to be installed.



**HINT:** Risks to human health and environment!

Wrong handling and no extraction system can cause production of particulate matter.

Particulate matter damages mostly the airways, because it gets inhaled. Following health effects related to particulate matter concentrations are generally known:

- Temporary impairments of the repertory
- Higher medication requirements for asthma patients
- Increased hospital admissions
- Increased mortality caused by cardiovascular problems and respiratory diseases

## 2.7 Behaviour in case of fire or accidents

### Preventive measures

- Always be prepared for accidents or fires!
- Keep first aid facilities (first aid box, blankets etc.) and fire extinguishers accessible at all times.
- Familiarise personnel with accident reporting, first aid and rescue equipment.
- Keep access routes clear for rescue vehicles.

### Measures for fire and accidents

- Cause emergency-stop by pressing emergency-stop-button immediately.
- If there is no risk for own health, remove all persons from the danger zone.
- Instigate first aid measures, if necessary.
- Call the fire brigade and/or rescue service.
- Fire: Fight fire with fire-extinguishers, if there is no risk for own health. Continue fire-fighting until fire-brigade arrives.
- Inform responsible persons at the place of action...
- Clear access routes for emergency vehicles.
- Instruct rescue vehicles.

## 2.8 Environmental protection



**HINT:** Risk for environment caused by carelessly handled hazardous substances!

Handling with hazardous substances can be dangerous for the environment if handled carelessly, especially when disposed wrong. This can cause severe damages to the environment.

- Please pay attention to the correct handling and disposal of below mentioned hazardous substances.
- If environmentally hazardous substances are accidentally released into the environment, take suitable measures immediately. In case of doubt inform the responsible local authority of the damage

<b>Lubricants</b>	Lubricants, such as grease and oils, contain toxic substances. They must not reach the environment. The disposal must be taken place by a specialised waste management company.
<b>Gear oil</b>	Gear oil contains many toxic substances. They must not reach the environment. The disposal must be taken place by a specialised waste management company.
<b>Cooling emulsion</b>	Cooling emulsion may contain toxic and polluting substances such as glycol. They must not reach the environment. The disposal must be taken place by a specialised waste management company.

## 2.9 Signage

Following symbols and signs are found in the working area. They apply to the immediate neighbourhood in which they are displayed.



**WARNING:**  
**Risk by illegibly signage!**

Over the years stickers and signs may become dirty or defaced in any other way; so that hazards are not recognized and necessary operating instructions have been adhered This is a risk of severe injury!

- Always keep safety, warning and operating instructions in a well legible condition.
- Immediately replace damaged or obliterated signs or labels.

## 2.9.1 Mandatory signs

### Take notice of instruction



Only use the machine after reading the instructions!

## 2.9.2 Prohibition signs

### Prohibitions for people with pacemakers



In the area of this sign a strong electromagnetically field is possible, which can disturb or disable pacemakers.

Persons with pacemakers must not stand near the machine.

### Prohibition for people with metal implants



Persons with metallic implants must not be allowed in the area of the machine.

Implants can heat themselves up or be drawn-in by the electro-magnetically field.

### Operation with necklace is prohibited



Risk of entrapment or entanglement in moving parts.

Take off necklaces before entering the signed area.

### Operation with tie prohibited



Risk of entrapment or entanglement in moving parts.

Take off tie before entering the signed area.

### Operation with long hair prohibited



Risk of entrapment or entanglement in moving parts. Persons with long hair have to wear a hair-net or hair cover.



---

### 2.9.3 Warnings

#### Voltage



In so signed areas only skilled electricians are allowed to work.

Unauthorized people must not enter these signed working areas or open so signed cupboards.

#### Automatic start



The start of the machine in production systems is indicated by a flashing light or acoustic signal. From this moment on all works must be finished.

After signalling, leave danger zone.

Always maintain an adequate distance to all moving parts, risk of hands, hair and clothing being drawn in.

#### Hot surface



Hot surfaces, such as hot machine parts, container and materials, may not always be noticeable. Do not touch without protective gloves!



---

## 2.9.4 Fire protection signs

### Fire alarm phone



The fire alarm phone may only be used in case of emergency.

Before fighting the fire, make an emergency call via fire alarm phone.

A fire alarm phone can be, in exception, even a simple phone that establishes a connection via telephone directly to the fire department, the operating station or to a person permanently present. In such cases, the following information is required:

- WHO reports?
- WHAT has happened?
- HOW MANY are affected / injured?
- WHERE has something happened?
- WAIT for questions!

### Fire extinguisher



Indication of a fire extinguisher.

Before fire extinguishers are brought to the fire, warn all persons in the danger zone or help to escape from the area. Only remove the fire extinguisher to put out a fire.

## 2.9.5 Exit signs

### First aid



The safety signs without an additional sign indicate a first-aid kit.

If further signs such as "medical station" or "first responders" are fitted, first aid professionals are additionally available.

In case of an emergency (even for minor injuries) use the material in the first-aid kit for first aid treatment of the injured person. When using or taking out first-aid materials registrations must be made in the accident book.

### Emergency exit



In a case of emergency, leave the danger zone through the emergency exit.

### Emergency phone



In case of an emergency, use the phone to alert.

The following details shall be transmitted to the monitoring station:

- WHO is calling?
- WHAT happened?
- HOW MANY are affected / injured?
- WHERE has it happened?
- Wait for questions!

### Escape



In a case of emergency, follow the suggested escape route in direction of the arrow. Emergency evacuation routes must always be kept clear.

### 3 Technical specifications

#### 3.1 General information

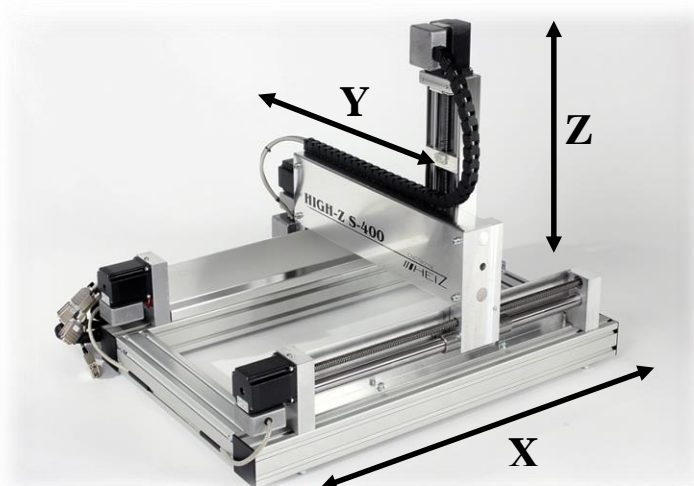

Figure 4: High-Z

#### Machine generally

Specification	High-Z S-400	High-Z S-720	High-Z S-1000
Length (L)	736 mm	1056 mm	1336 mm
Width (W)	570 mm	690 mm	870 mm
Height (H)	570 mm	570 mm	570 mm
Weight without work surface and tool	ca. 32,5 kg	ca. 39,5 kg	ca. 45 kg
Clamping surface (LxW)	730 x 390 mm	1050 x 510 mm	1330 x 690 mm
Passage height	103 mm (from the upper edge of the frame)		

#### Traversing ranges

Specification	High-Z S-400	High-Z S-720	High-Z S-1000
X-axis	400 mm	720 mm	1000 mm
Y-axis	300 mm	420 mm	600 mm
Z-axis	110 mm	110 mm	110 mm

**Other parameters**

Specification	High-Z S-400	High-Z S-720	High-Z S-1000
Positioning speed (Rapid traverse XY)	66 mm/sec <sup>1</sup>	66 mm/sec <sup>1</sup>	66 mm/sec <sup>1</sup>
working speed (XY)	50 mm/sec <sup>1</sup>	50 mm/sec <sup>1</sup>	50 mm/sec <sup>1</sup>
Positioning speed (Rapid traverse Z)	30 mm/sec	30 mm/sec	30 mm/sec
Steps/U at 1/10-Step Control	2000	2000	2000
Thread pitch XY	6 mm	6 mm	6 mm
Thread pitch Z	6 mm	6 mm	6 mm
Round bar guide XY	22 mm	22 mm	22 mm
Circular waveguide Z	16 mm	16 mm	16 mm
Programmable resolution XYZ	0,003 mm	0,003 mm	0,003 mm
repeatability	0,01mm	0,01mm	0,01mm
backlash	+ - 0,03mm	+ - 0,03mm	+ - 0,03mm
Drive X-axis	2 Step motors Nanotec Type ST5918L3008-A		
Drive Y axis	1 Step motor Nanotec Type ST5918L3008-A		
Drive Z axis	1 Step motor Nanotec Type ST5918L3008-A		
reference switch	Meder Reed Sensors Type Mk04 non-contact on all three axes		

<sup>1</sup> Measured in the diagonal drive X + Y (depending on contour shape)

### 3.2 Power values

Feed drives X / Y / Z	specification	value	unit
	Power consumption per motor max.	4,2	A

### 3.3 Operating conditions

Environment	Specifications	value	unit
	temperature range	15-30	°C
	Relative humidity maximum	60	%

Duration	Specification	value	unit
	Maximum operating time per session	100	h
	Pause until the next session	2	h

### 3.4 Working materials

Working materials	Type
Low friction grease	multipurpose grease Acid and resin free
Low friction oil	Fine mechanics oil Acid and resin free

### 3.5 Emissions

Specification	Value	Unit
Noise emissions	ca. 50	dB(A)

### 3.6 Type plate

The type plate is located on the frame of the portal system (Figure 5 /Arrow) and includes the following information:

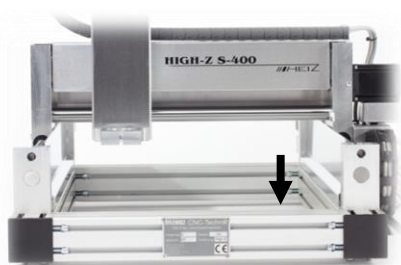

Figure 5: Location of type plate



Figure 6: Type plate

- Manufacturer
- Type of plant
- Year
- Serial number
- Version

## 4 Structure and functions

### 4.1 Overview

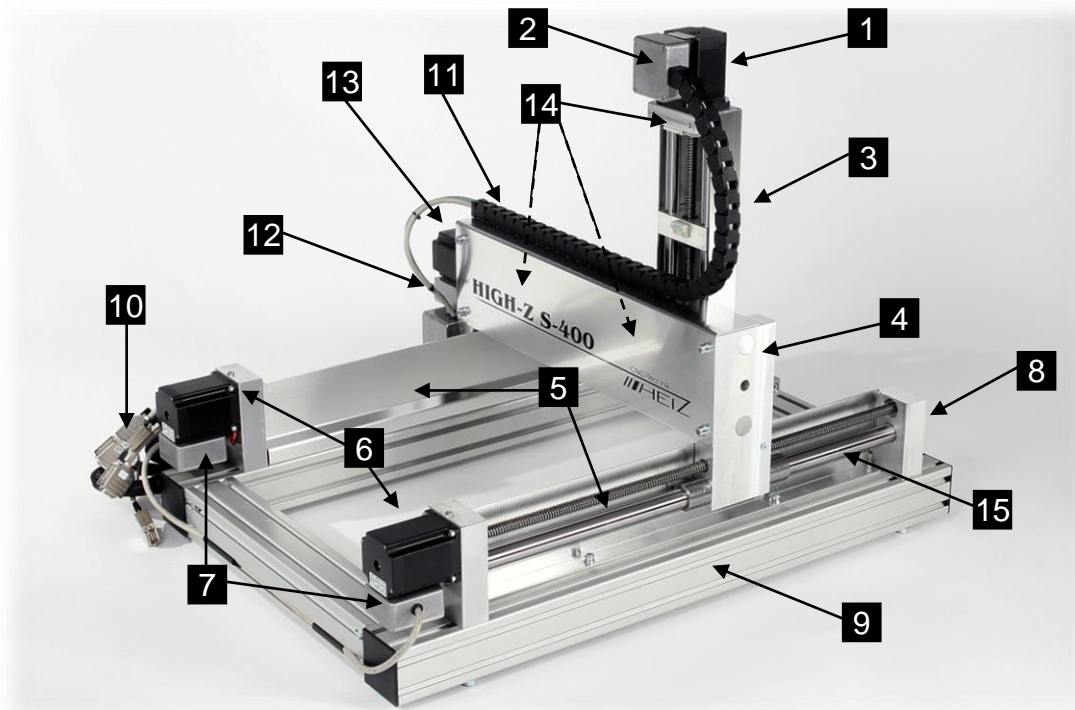

Figure Overview HIGH-Z

- |  |   |
|--|---|
| 1 Stepper motor of the Z-axis                      | 9 framework   |
| 2 Terminal box of the stepping motor of the Z-axis | 10 Stepping motor control cable                     |
| 3 Z-axis with carriage                             | 11 Energy chain guide                               |
| 4 Y-axis with carriage(Y-bridge)                   | 12 Terminal box of the stepping motor of the Y-axis |
| 5 X-axis with carriage                             | 13 Stepper motor of the Y-axis                      |
| 6 Stepper motors of the X-axis                     | 14 Reference switch XYZ                             |
| 7 Terminal boxes of the step motors of the X-axis  | 15 Round bar guide                                  |
| 8 Floating-bearing bumping-stop of axis            |   |



## 4.2 Brief description of the application range

### Usage of the machine

The machine is used in conjunction with a tool for:

- Milling
- Engraving
- Cutting
- Drilling
- Laser Engraving
- Grinding
- Plasma cutting
- Welding
- Dosing
- Measuring
- Positioning

### Short Description

The machine cannot function alone. The following additional components (accessories) are necessary for operation:

- **Control** which consists of a PC with the right configuration with struck up control software (e.g. WinPc-NC, Mach3, USBCNC) and a stepper motor control (e.g. Zero3).
- **Tool** with 43mm intake for direct clamping into the holder provided.
- **Accessories**, see Appendix

The machine consists of an aluminium frame construction, which is kept open for large work pieces.

### Control via operating software

To control it requires a CNC-CAM-software.

In a design-/graphic-program (e.g. ConstruCAM 3D, Corel Draw, AutoCad, etc.) the drawings or texts are created and stored in a suitable format. This data can be (e.g. WIN PC-NC) read by the control software.

Via control the stepper motors for the axis-movement are controlled. By stepping motors and the driven trapezoidal screw, a conversion of rotary motion into linear is carried out.

## 4.3 Module Description

### 4.3.1 Z-axis with carriage

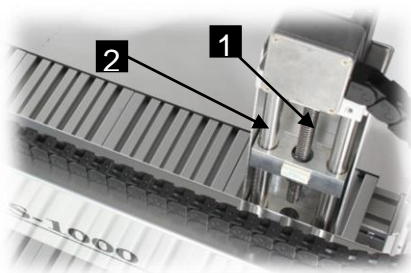

Figure 8a: Z-Carriage

- 1 Trapezoidal thread spindle
- 2 linear guides

The two linear guides (Figure 8a /2) guide into the inclusion of the accessory bracket. The trapezoidal threaded spindle (Fig. 8a / 1) represents the Z-axis on which the accessory holder with a suitable tool (4 inclusion) moves along the Z-linear guides

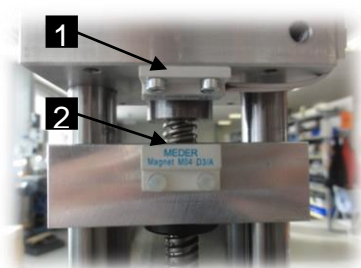

Figure 8b: Z-Carriage

- 1 Reference switch Z-axis
- 2 Magnetic contact

The reference switch (Fig. 8b / 1) responds to the magnetic field of the incoming homing magnet (Fig. 8b /2). If the magnet is close enough the reed sensor of the switch turns on.

The reference switch operates as closing contact; in switched state the signal circuit is closed.



#### **HINT:**

Reference switches are required for axes without absolute position encoder to feature in the initialization of the axis by a known reference point (zero point of the axis). From this position, all other positions are then calculated relative to the process of the axis via software.

### 4.3.2 Y-axis with carriage

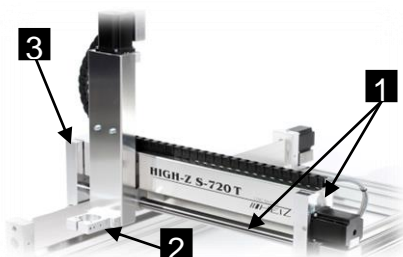

Figure 9a: Y-Carriage

- 1 Linear guides (upper linear guide is covered)
- 2 Tool holder (43H7 holder)
- 3 Y-bridge
- 4 Trapezoidal threaded spindle (also behind the cover)

The two linear guides (Fig. 9a / 1) and the Trapezoidal Thread Spindle located on the Y-bridge (Fig. 9a / 3) and represent the Y-axis. Along the Y-Bridge is the tool holder (Fig. 9a / 2) which can be moved with a suitable tool (43H7 holder)

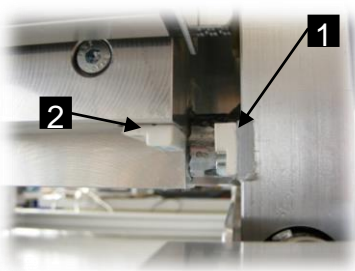

Figure 9b: Y-Carriage

- 1 Reference switch Z-axis
- 2 Magnetic contact

The reference switch (Fig. 9b / 1) responds to the magnetic field of the incoming homing magnet (Fig. 9b / 2). If the magnet is close enough the reed sensor of the switch turns on.

The reference switch operates as closing contact; in switched state the signal circuit is closed.



#### **HINT:**

Reference switches are required for axes without absolute position encoder to feature in the initialization of the axis by a known reference point (zero point of the axis). From this position, all other positions are then calculated relative to the process of the axis via software.

### 4.3.3 X-axis with carriage

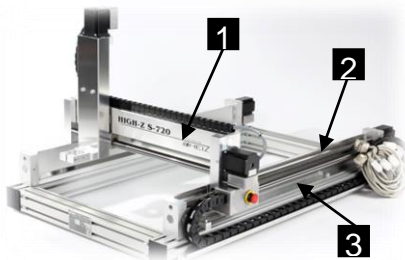

Figure 10a: X-Carriage

- 1 Y-bridge
- 2 linear guide
- 3 Trapezoidal thread spindle

The figure shows the X-linear guide (Fig. 10a / 2) with trapezoidal threaded spindle (Fig. 10a / 3) from one side of the machine.

The second X-linear guide with trapezoid thread spindle is positioned symmetrically on the other side of the machine. The two linear guides represent the X-axis, on which the Y-bridge is moved (Fig. 10a / 1) along the X linear guides.

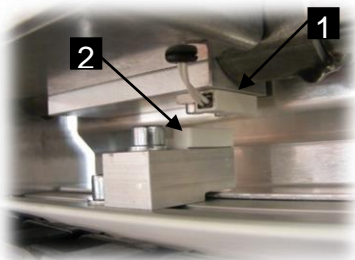

Figure 10b: X-Carriage

- 1 Reference switch Y-axis
- 2 Magnetic contact

The reference switch (Fig. 10b / 1) responds to the magnetic field of the incoming homing magnet (Fig. 10b / 2). If the magnet is close enough the reed sensor of the switch turns on.

The reference switch operates as closing contact; in switched state the signal circuit is closed.



#### **HINT:**

Reference switches are required for axes without absolute position encoder to feature in the initialization of the axis by a known reference point (zero point of the axis). From this position, all other positions are then calculated relative to the process of the axis via software.

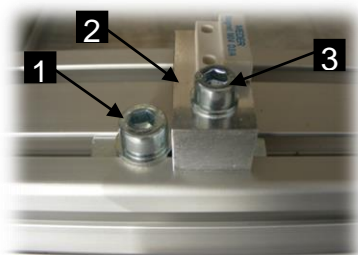

Figure 10c: X-Carriage

- 1 stop (M8 screw)
- 2 magnet holder of the X axis
- 3 mounting screw magnet holder (M6 screw)

The M8 screw (Fig. 10c / 1) serves as a stop for the magnet holder (Fig. 10c / 2). This stop is required to locate the factory setting, if for reasons of user-defined settings the magnet holder was transferred.

To move the magnet holder (Fig. 10c / 2) loosen the fixing screw (Fig. 10c / 3), move the magnet holder along the groove to the desired position and secure with the fixing screw to prevent loosening



#### **HINT:**

If the position of the magnet holder of the X-axis is changed, settings must be taken into account in the control software under the topic “working space”.

### 4.3.4 Tool holder

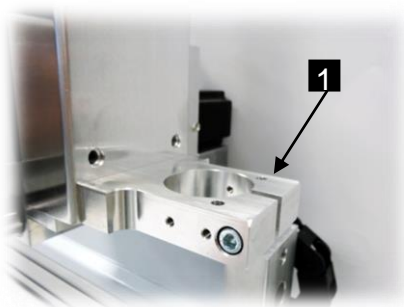

Figure 11: Tool holder 43H7

On the tool holder of the Z-axis (Fig. 11/1) are some of the most important additional available tools attached (see Appendix "Accessories").

## 4.4 Controls

The machine does not have its own controls for moving the axes. This is possible with separate interfaces (e.g. stepper motor control Zero3)

## 4.5 Connections



*Fig. 12: Stepper motors*

The connectors of the step motor cables or control line ST are labelled as follows:

- Connector X1 stepping motor of the X-axis.
- Connector X2 stepping motor of the X-axis.
- Plug Y stepping motor of the Y-axis.
- Plug-Z stepper motor Z-axis.
- Connector ST Emergency, Ref-switch and socket Pin15.



*Fig. 13: Connection ST and. Motor connection*

The connection of the stepper motors or the reference switch and emergency stop signal are carried out via depicted lines marked on each Sub-D connector (Fig. 13).

For pin assignment see Figure 14 and Figure 15.

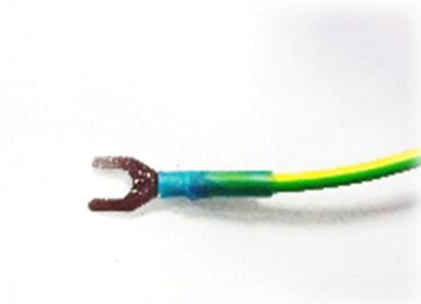

*Fig. 13a: Ground*

Ground Connection to Zero-3 Controller



*Fig. 13b: Zero-3*

### 4.5.1 Control signals (ST)

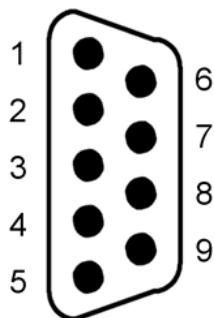

Figure 14: Belegung  
Steuerstecker

Sub-D

Pin Nr.	Signal
1	Limit C / Pin15 jack High-Z
2	limit X
3	limit Y
4	limit switch Z
5	Emergency stop (closed = OK, open = stop)
6	N.C.
7	N.C.
8	N.C.
9	Ground, shield

### 4.5.2 Motor connector (X1,X2,Y,Z)

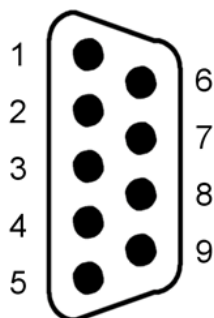

Figure 15: Belegung Motorstecker  
Sub-D

Pin Nr.	Signal
1+6	Motor winding A +
2+7	Motor winding A-
3+8	Motor winding B +
4+9	Motor winding B-
5	Ground, shield

### 4.5.3 MiniXLR pin socket (Pin15)



The pin 15 is connected via socket which is available on the machine (Fig. 16). This allows additional optional applications (e.g. zero button, length sensor, 3D buttons) that can be integrated via Pin15.

*(Info for pin assignment see Figure 17)*

Figure 16: miniXLR socket

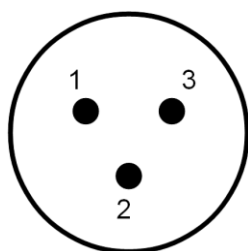

Pin Nr.	Signal
1	Signal contact 1
2	N.C.
3	Signal contact 2

Figure. 17: Anschluss Pin15



## 4.6 Work and danger areas

### 4.6.1 Working area

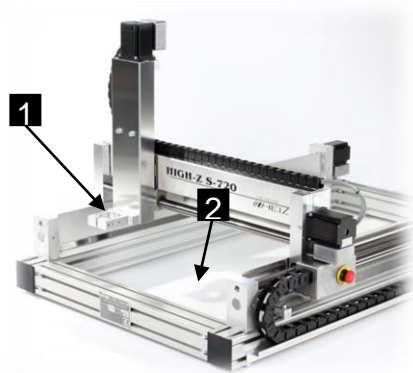

Figure. 18: Working area

- PC (Accessories)
- area of the tool holder (Fig. 18/1) (when turned off)
- Range of motion of the axes (Fig. 18/2) (when turned off) in order to clamp work pieces

### 4.6.2 Danger zone



Figure. 19: Danger zone

- Total area of machinery in operation

## 5 Transport, packaging and storage



**HINT:**

As part of the installation and the further use the operator or maintenance personnel must be entrusted by the operator with the handling of packages. Always observe the instructions listed below.

### 5.1 Safety instructions for transport

#### Suspended loads



**WARNING:**

**Danger to life due to suspended loads!**

When lifting operations are carried out loads can swing out and fall off. This may lead to serious injury or death.

- Never stand under or into the swivel area of a suspended load.
- Loads are only to be moved only under supervision.
- Use only approved lifting gear and lifting gear with sufficient load-bearing capacity.
- Do not use damaged or frayed lifting equipment such as ropes and straps.
- Lifting equipment such as ropes and straps must not be laid on sharp edges and corners do not twist or knot.
- When leaving the workplace settle the load.

#### Eccentric focus



**WARNING:**

**Risk of injury by falling or tipping packages!**

Packages may have an off-centre focus. The wrong kind sling gear attachment can tilt the packing crate and cause life-threatening injuries.

- Observe the markings and details on the focus on the package.
- Attach the crane hook so that it is directly above the centre of gravity.
- Lift cautiously and observe whether the load tilts.

### Improper transport



**HINT:**

Property damage due to improper transport!

Improper transportation can cause considerable material damage.

- When unloading delivered packages and when transporting on the premises, proceed with caution and adhere to the symbols and instructions on the packaging.
- When slinging the load all attachment points provided by the manufacturer have to be used in accordance with the specifications.
- Do not remove packing until just before the installation.

## 5.2 Transport inspections

Check the delivery immediately on receipt for completeness and transport damage.

Proceed in case of visible damage as follows:

- Do not accept the delivery or only under reserve.
- Record the scope of the damage on the transport documents of the carrier, or on the delivery note.
- Lodge complaint.



**HINT:**

Lodge a complaint for each defect, as soon as it is recognised. The claims for damage must be filed in the lawful reclaim periods.

## 5.3 Packaging

### Regarding packaging

The individual packages are packed according to the expected transport conditions. Environmentally friendly material is used exclusively for the packaging.

The packing has the function of protecting the individual components against damage, corrosion, etc., until they are finally assembled. Therefore, do not damage the packaging and only remove immediately before installation.

### What to do with packing materials

Dispose of packaging material in accordance with the respective valid laws and local regulations.

### Non-central centre of gravity



**HINT:**

**Danger for environment due to improper disposal!**

Packing materials are valuable raw materials and can continue to be used in many cases or sensibly reconditioned and recycled. Incorrect disposal of packaging materials, may lead to risks to the environment.

- Dispose packaging material environmentally friendly.
- Adhere to the valid local regulations for disposal.



## 5.4 Symbols on packaging

The following symbols are shown on the packaging. Always heed the symbols during transport.

### Fragile



Identifies packages with fragile or delicate contents.  
Treat the package with care, do not drop or bump it.

### Do not stack



In the designated packages or goods should not be stacked.

### Protect from moisture



Protect packages from moisture and keep dry.

## 5.5 Transport

### Sling points

The machine may only be transported and slinged in the frame.

### Transport of pallets with the crane

Transport pieces, which are fastened on a pallet can be transported by a crane under the following conditions:

- Crane and lifting gear must be designed for the weight of the transported items.
- The operator must be authorised to operate the crane.

### Slinging

protective equipment:      • Industrial safety helmet

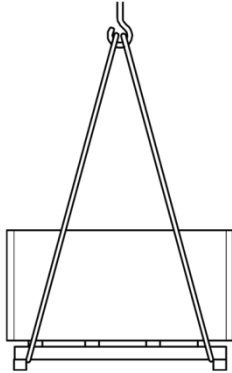

Figure 20: lifting gear

- 1 Sling on ropes, belts accordingly (Fig. 20) to the pallet and secure pallet against slipping.
- 2 Check whether the transport pieces are not damaged by the slinging materials. If necessary, use other slings.
- 3 Make sure that the pallet with off-centre gravity cannot tip.
- 4 Start the transport.

### Transport of pallets with a forklift

Transport pieces, which are attached to pallets can be transported under the following conditions using a forklift:

- The fork lift must be rated for the weight of the transport pieces.
- The transport package shall be securely fastened on the pallet.
- The folk lift driver must be authorized to drive industrial trucks with driver's seat or driver's cab according to national regulations.

### Transport

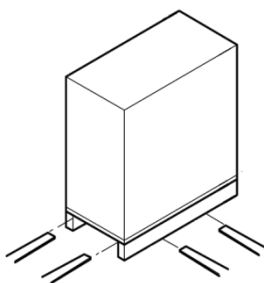

Figure 21: Transportation by forklift

- 1 Drive the forklift with the forks between or the holms of the pallet.
- 2 Drive the forks so far that they protrude on the opposite side.
- 3 Make sure that the pallet with off-centre gravity cannot tilt.
- 4 Lift the pallet with transport piece and start the transport.

## 5.6 Storage

### Storage of packages

**Packages should be stored under the following conditions:**

- Do not store outdoors.
- Dry and dust free.
- Not exposed to corrosive media.
- Protect from sunlight.
- Avoid mechanical shocks.
- Storage temperature: 10 to 35 ° C.
- Relative humidity: max. 60%.

For storage longer than 3 months regularly check the general condition of all parts and packaging. If necessary, refresh or renew the preservative.



**HINT:**

Further instructions for storage may be found on the packaging, which go beyond the requirements listed here. These comply accordingly.



## 6 Installation and commissioning

### 6.1 Safety instructions for the installation and commissioning

#### Suspended loads



**WARNING:**

**Danger to life due to suspended loads!**

When lifting, loads can swing out and fall off. This may lead to serious injury or death.

- Never stand under or into the swivel area of a suspended load.
- Loads are only to be moved only under supervision.
- Use only approved lifting gear and lifting gear with sufficient load-bearing capacity.
- Do not use damaged or frayed lifting equipment such as ropes and straps.
- Lifting equipment such as ropes and straps must not be laid on sharp edges and corners do not twist or knot.
- When leaving the workplace settle the load.

#### Improper installation and commissioning



**WARNING:**

**Risk of injury by improper installation and commissioning!**

Improper installation and commissioning can lead to severe injuries and substantial property damage.

- Before starting any work sufficient installation freedom is required.
- Handle open, sharp-edged components with care.
- Maintain order and cleanliness at the installation site! Loosely stacked or scattered components and tools are accident sources.
- Install components professionally. Comply with the specified screw tightening torques.
- Secure components so they do not fall down or fall over.
- Note following guidelines before commissioning:

Ensure that all installation work in accordance with the information and instructions were carried out and completed in this guide. Ensure that there are no persons in the danger zone.





## Screw tightening torques



**HINT:**

**Property damage caused by incorrect screw tightening torques!**

All screws on the machine have been tightened before delivery to the appropriate torque.

Additional tightening leads to undesired tensions in the machine and thus to inaccurate machining of the work pieces.

- **Tighten No screws on the machine!**

## 6.2 Preparations

### 6.2.1 Install machine

- Personnel:
- Specialist personnel
- Safety equipment:
- Protective clothing
  - Safety shoes
  - Industrial protective helmet



**ATTENTION:**

**Risk of injury by under-sized buildings!**

Overload of ceiling structures can lead to serious damage and personal injury!

- If the machine is situated on a cantilevered building ceiling, note the dynamic loads due to the movements.

### Uneven ground



**HINT:**

**Material damage caused by uneven ground!**

Due to uneven ground deformations are caused within the machine. This results in an imprecise machining of the work pieces.

- Place the machine on a flat and level surface.

1. Place the machine on a level, vibration-resistant surface.
2. horizontal align (Utilities water balance).

## 6.2.2 Install worktop

The worktop (not included) may be as following, according to mounting maximum dimensions.



Figure 22: Clamping range

Modell HIGH-Z	Dimensions of the worktop in frame
S-400	610 x 390mm
S-720	930 x 510mm
S-1000	1210 x 690mm
Modell HIGH-Z	Dimensions of the worktop on frame
S-400	730 x 390mm
S-720	1050 x 510mm
S-1000	1330 x 690mm

Fixing the worktop is done by yourself. As a recommendation, grooves in the frame of the aluminium profile in conjunction with matching T-nuts (8mm groove width) can be supplied.

## 6.3 Installation

### 6.3.1 Connecting the computer



**HINT:**

The connection of the PC / computer to the stepper motor is controlled according to the information belonging to the stepper motor controller manual.

### 6.3.2 Connecting the stepper motor and control cable



#### ATTENTION:

#### Risk of tripping and falling!

Exposed wires on the ground can lead to tripping or slipping.

- On the ground laid cables should be covered.
- Do not lead past corners and sharp edges.
- Avoid chafing.
- Visibly mark line course.

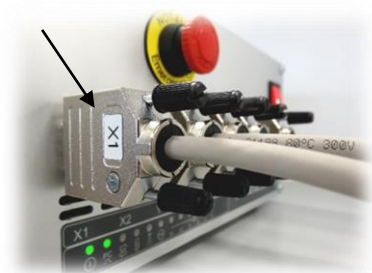

The connectors of the stepping motor, and control lines (Fig. 23 / arrow) are labelled.

Personnel: • specialist personnel

Figure 23: Connections

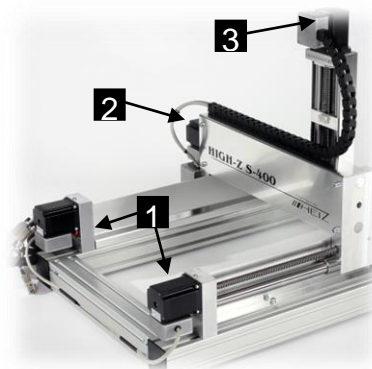

Figure 24: Stepper motors of axes

- 1 Connect the plug of the stepper motor and control cable with the following assignment to the stepper motor controller:
  - X-axis stepper motor (Fig. 24/1) to terminals X1 and X2 of the stepper motor controller
  - Y-axis stepper motor (Fig. 24/2) to terminal Y, the stepping motor control
  - Stepper motor Z-axis (Fig. 24/3) to terminal Z of the stepper motor control
  - Emergency stop switch, limit and reference switches to port ST stepper motor control
- 2 Secure cable connections with the knurled screw from loosening.

### 6.3.3 Installing Accessories



**HINT:**

The equipment installation is carried out according to the specifications of the accessories associated operating and assembly instructions.



**WARNING:**

**Risk of injury due to improperly mounted accessories!**

Improperly mounted accessories can lead to uncontrolled falling or throwing out during operation and cause serious injury to skin and eyes.

- Mount accessories professionally according to the safety regulations.

#### Install milling motor

Personnel: • Specialist personnel

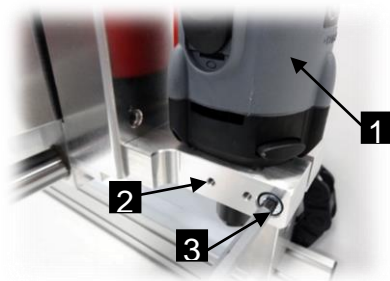

- 1 Tool, for example milling motor with 43mm neck Euro (Fig. 25/1) insert in the tool holder (Fig. 25/2) on the Z carriage.
- 2 Tighten screw (Fig. 25/3) lightly until a clamping is done
- 3 Check milling motor for tightness in the accessory holder.

Figure 25: Tool holder with milling



**HINT:**

**Property damage caused by excessive tightening!**

When excessive tightening the screw for mounting the milling motor, the main bearing of the cutter motor may be damaged.

- Never tighten the screw (Fig. 25/2) for fixing the milling motor, excessively.

*Only use the short side of an allen key for manual tightening!*

## 6.4 Initial start-up

Personnel:      • Specialist personnel

- 1 Make sure that the machine is installed and aligned.
- 2 Ensure that the stepper motor, and control lines are connected to the stepper motor controller
- 3 Make sure that the computer is connected to the stepper motor control of the machine.
- 4 Ensure that required accessory is installed and connected to the power supply.
- 5 Ensure that the appropriate software is installed on the PC.
- 6 Ensure the tightness of all connections.



**HINT:**

The individual materials have different coefficients of expansion. At an ambient temperature of 20-25 ° C it is ensured that no significant impacts occur during processing. Therefore, it is recommended to maintain an ambient temperature of 20-25 ° C when operating the machine.

## 7 Operation

### 7.1 Safety guidelines for operation

#### Improper operation



**WARNING:**

**Risk of injury by improper operation!**

Improper operation can result in serious injuries and significant property damage.

- Perform all operations in accordance with the information and instructions of this manual. Note the following before beginning work:
  - Make sure that all covers and safety devices are installed and working properly.
  - Ensure that there are no persons in the danger zone.
- Never bridge or disable safety devices during operation.

### 7.2 Operations before usage

- 1 Make sure that all covers are installed on the machine.
- 2 Ensure the tightness of all connections.
- 3 Make sure that none of the emergency stop switch is pressed.
- 4 Check the ambient temperature.



**HINT:**

The individual materials have different coefficients of expansion. At an ambient temperature of 20-25 ° C it is ensured that no significant impacts occur during processing. Therefore, it is recommended to maintain an ambient temperature of 20-25 ° C when operating the machine.

### 7.3 Switching on

Personnel: Operator

- 1 Turn on the computer and boot the software.
- 2 Clamp work piece



- 3 Ensure that required tool is in the tool holder, if necessary, change the tool, and see the separate operating instructions for the accessories.
- 4 Ensure that no tools or other foreign objects are in the machine or system.
- 5 Make sure that no persons are in the danger zone.
- 6 Connect required accessories to the provided power supply.
- 7 Switch on the stepper motor control; refer to the separate operating instructions for the step motor control.
- 8 Perform reference run.
- 9 Zero point determination.
- 10 Start Job.

## 7.4 Activities during operation

### 7.4.1 Operating machine

- Personnel:
- Operator
- Safety equipment:
- protective clothing
  - Safety shoes
  - Goggles
  - protective gloves
  - Hearing protection
  - Protective cover

#### Rotary tools



**WARNING:**  
**Risk of injury from rotating tools!**

In spindles clamped tools may result in serious personal injury or property damage.

- Before starting work, ensure that all covers and safety devices are installed and working properly.
- Do not reach into moving tool during operation.
- Before replacing the tools always pull power plug of the milling motor or turn off the machine and secure against reconnection.

#### Axis movements



**WARNING:**  
**Risk of injury due to axis movements!**

Collision of people with components of the machine (Y-bridge, mobile unit, rotary table with the work piece, tool) can lead to serious injuries.

- Keep anybody parts away from in-between the moving parts and end stops of the axes.
- Do not grab in gaps between adjacent components of linear guides and access adjacent components
- Perform work on the linear guides only at standstill.
- In the work area wear personal protective equipment.

#### Magnetically fields



**DANGER:**  
**Danger to life due to magnetic fields!**

Magnetic fields of stepper motors can cause serious injury and even death and substantial property damage.

- Persons with pacemakers must not go near the machine itself. The function of the pacemaker may be affected.
- People with metal implants should not be in the vicinity of the machine itself. Implants can heat up or be attracted
- Before servicing take off metal objects (jewellery, watches, writing instruments, etc.).
- Do not bring any electronic devices in the vicinity of the magnetic source. These could be damaged.
- No storage media, credit cards, etc. placed in the vicinity of the magnetic source. Data can be deleted.

#### Falling materials



**WARNING:**  
**Injuries caused by falling materials!**

In operation, chips, tools (or parts thereof) may fall uncontrollably down or may be thrown out and cause serious injury to skin and eyes.

- Wear face shield or fully enclosed goggles, protective clothing, gloves and safety shoes.
- If particles enter the eye, seek immediate medical attention.





### Unexpected start of the machine



**WARNING:**

**Risk of injury from unexpected starting of the machine!**

The machine and the tools may start unexpectedly, change direction or stop. Limbs can get captured.

- Make sure that no body parts enter the danger area of the machine.
- Secure work area from accidental access.

### Highly inflammable substances



**WARNING:**

**Fire hazard due to flammable materials!**

Organic dusts from coal or wood or inorganic dust of magnesium, aluminium, zinc or titanium can catch fire and cause serious or even fatal injuries.

- Within the danger zone and in the vicinity do not smoke. Do not use open flames or sources of ignition.
- Keep fire extinguisher ready.
- Processing of light metal alloys such as magnesium, aluminium, zinc and titanium without suction and appropriate security measures is not allowed.
- Stop work immediately in case of fire. Evacuate danger area until the all-clear is given.

### Cooling emulsion



**ATTENTION:**

**Risk of health damage by contact with cooling emulsion!**

Contact with cooling emulsion can lead to health damage.

- Avoid skin contact.
- Remove the cooling emulsion immediately from the skin.
- Do not inhale vapours

### Operation with coolant



**HINT:**

For more information, refer to the manufacturer's instructions of the coolant.



## 7.4.2 Change tool

- Personnel:
- Operator
- Safety equipment:
- protective clothing
  - Safety shoes
  - protective gloves

- 1 Make sure that the tool (e.g. milling motor, tangential knife, etc.) is de-energized (Connecting cable, pull out the mains plug or power button press)



**ATTENTION:**

**Risk of burns from hot surfaces! Risk of being cut by tools and chips!**

Contact with hot components can cause burns. Tools and chippings can cause injury when touched.

- When changing tools, wear protective gloves.

- 2 Change tool, see the separate operating and assembly instructions
- 3 Make sure that the tool is again provided with voltage (connection cable, connect the power plug or switch power button)

## 7.5 Switching off

- 1 Turn power switch on the stepper motor control to "0" or "Off"; see separate operating instructions for the step motor control.
- 2 Stop software for the machine on the computer.
- 3 Shut down computer.



## 7.6 Activities after use

- Personnel:
- Operator
- Safety equipment:
- protective clothing
  - Safety shoes
  - protective gloves

1. Turning off the machine.



**ATTENTION:**  
**Risk of injury by chips!**

Chips can be sharp and cause deep lacerations.

- Always wear protective gloves when removing chips.

2. Clean the machine (see chapter 8.4).

## 7.7 Emergency Shutdown

In hazardous situations, movements of components must be stopped as soon as possible and the power supply must be switched off.

### Stopping in an emergency

- 1 Immediately activate emergency stop by emergency stop device.
- 2 If there is no danger for your health, remove persons from the danger zone.
- 3 If necessary, initiate first aid measures.
- 4 Call Fire department and / or ambulance service.
- 5 Inform the responsible person on site.
- 6 Turn the machine off and secure it against being switched on again.
- 7 Keep access routes for emergency vehicles free.
- 8 Instruct rescue vehicles.

## 8 Maintenance

### 8.1 Safety Instructions for maintenance

#### Moving components



**WARNING:**

**Risk of health damage by contact with cooling emulsion!**

Contact with cooling emulsion can lead to health damage.

- Avoid skin contact.
- Remove the cooling emulsion immediately from the skin.
- Do not inhale vapours.

#### Electrical System



**DANGER:**

**Danger to life due to electric current!**

Contact with live components can be fatal. Activated electrical components can run uncontrolled movements and cause serious injury.

- Switch off the electrical supply before starting work and secure against reconnection.

#### Improperly performed maintenance



**WARNING:**

**Risk of injury by improperly performed maintenance!**

Improper maintenance can lead to severe injuries and substantial property damage.

- Before starting any work, ensure installation freedom.
- Maintain order and cleanliness at the installation site! Loosely stacked or scattered components and tools are accident sources.
- If components have been removed, ensure correct assembly, reinstall all fasteners and note correct screw tightening torques.
- Note following before re-starting :
  - Ensure that all maintenance work has been done in accordance with the information and instructions were carried out and completed in this guide.
  - Ensure that there are no persons in the danger zone.
- Make sure that all covers and safety devices are installed and working properly.



## Environmental protection

Observe the following instructions to protect the environment during maintenance:

- On all lubrication points which are supplied with lubricant by hand, remove escaping, used or excess grease and dispose in accordance with applicable local regulations.
- Decant oils in suitable containers and dispose according to local regulations.
- Catch oil / fat-containing cloths in suitable containers and dispose according to local regulations.

## 8.2 Spare parts



### **WARNING:**

#### **Risk of injury due to using unapproved replacement parts!**

The use of incorrect or faulty spare parts can lead to hazards to personnel and malfunction or failure of the machine.

- Only use original spare parts from the manufacturer or manufacturer-approved replacement parts.
- If in doubt always contact the manufacturer.



### **Loss of warranty**

The use of non-approved spare parts invalidates the manufacturer's warranty.

Obtain spare parts from authorized dealers or directly from the manufacturer.

The spare parts list is available on request.

Specify following points when ordering spare parts:

- Type
- Year built
- Serial no.
- Version
- Amount
- Identification
- desired delivery method (mail, cargo, sea, air, express)
- shipping address

Spare part orders without above information will not be considered. If no specification is made regarding the shipping method, shipping will be at the discretion of the supplier.

### 8.3 Maintenance Schedule

In the following sections, the maintenance is described that is necessary for optimum and trouble-free operation of the machine. If increased wear can be seen during regular inspections reduce the required maintenance intervals according to the actual wear and tear. For questions about maintenance work and intervals, contact the manufacturer.



Refer to the separate operating instructions, for the maintenance of the supplied components.

#### Modell HIGH-Z Series S-400 / S-720 / S-1000

Interval	Maintenance	To be carried out by
Daily	Cleaning the machine	Operator
	Check the machine for damage and wear	qualified personnel
10 Hours	Grease Trapezoidal Thread Spindle	qualified personnel
	Oil linear guides	qualified personnel
50 Hours	Grease motor bearings through the provided funnel type lubrication fitting	qualified personnel
As required	Clean the machine from the outside with a cloth DIN 61650	Operator

## 8.4 Maintenance

### 8.4.1 Cleansing of the machine



Regular maintenance of the machine prevents sticking of moving parts.

- Personnel:
- Operator
- Safety equipment:
- protective clothing
  - Safety shoes
  - protective gloves

- 1 Turn power switch on the stepper motor control to "0" or "Off"; see separate operating instructions for the step motor control.
- 2 Free machine from chips.



**ATTENTION:**  
**Risk of injury by chips!**

Chips can be sharp and cause deep lacerations.

- Always wear protective gloves when removing chips.

- 3 Free Trapezoidal Thread Spindle and linear guides from chips
- 4 Clean the entire machine with a slightly oily cloth DIN 61650

## 8.4.2 Lubricate machine

The lubricants reduce wear, protect against pollution, reduce corrosion and prolong the service life by their properties.



For supplies, see chapter 3.4.

### Grease Trapezoidal Thread Spindle

Personnel:

- Qualified personnel

Safety equipment:

- protective clothing
- Safety shoes
- Chemical-resistant gloves

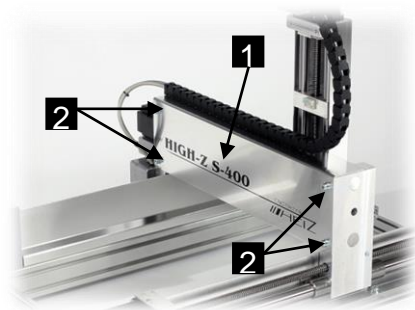

- 1 Switch off the machine and secure against re-start.
- 2 Loosen and remove the four screws (Fig. 26/2).
- 3 Remove the cover (Fig. 26/1) on the Y-axis.

Figure 26: Lid Y-axis



#### **ATTENTION:**

#### **Risk of health damage by contact with oil and grease!**

Contact with oil and fat can lead to health damage.

- Avoid skin contact.
- Remove Oil and grease immediately from the skin.
- Do not inhale vapours.



### Oil linear guides

- Personnel:
- Qualified personnel
- Safety equipment:
- protective clothing
  - Safety shoes
  - Chemical-resistant gloves

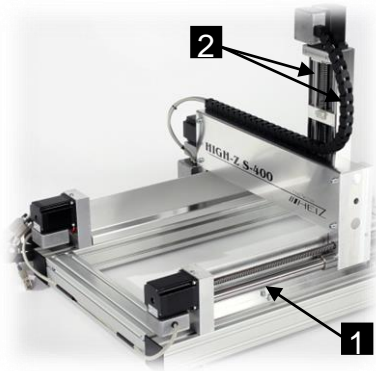

Figure 28: linear guides of the X and Z-axis

- 1 Switch off the machine and secure against re-start.
- 2 Grease the linear guides of the X-axis (Fig. 28/1), the Z-axis (Fig. 28/2) well using a low-friction grease wetted cloth DIN 61650 or alternatively apply the fat with a suitable brush.

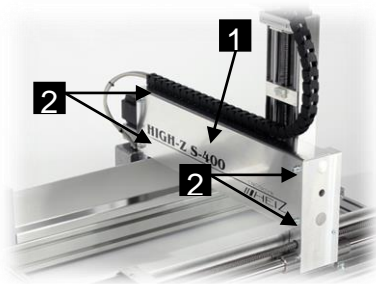

Figure 29: Cover Y-axis

- 2 Loosen and remove the four screws (Fig. 29/2).
- 3 Remove the cover (Fig. 29/1) on the Y-axis.

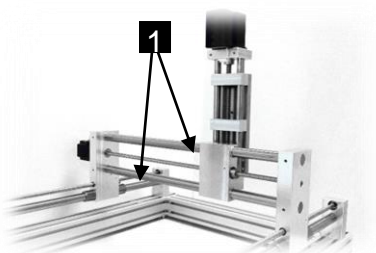

Figure 30: Linear guide the Y-axis

- 4 Grease the linear guides of the X-axis (Fig. 30/1) well using low-friction grease soaked cloth DIN 61650 or alternatively apply the grease with a suitable brush.

---

### Grease Lubrication nipple on the motor bearings

- Personnel:
- Qualified personnel
- Safety equipment:
- protective clothing
  - Safety shoes
  - Chemical-resistant gloves
- Special tool:
- Grease gun

### Grease nipple X-axis (2 pcs.)



*Figure 31: grease nipple X-axis*

- 1 Switch off the machine and secure against re-start.
- 2 Put Grease Gun onto the grease nipple on the X-axis.
- 3 Operate Grease Gun once or twice.
- 4 Remove grease gun.
- 5 Put Grease Gun onto the grease nipple of the other X-axis
- 6 Perform working steps 2-4.

### Grease nipples of the Y-axis (1 pc)

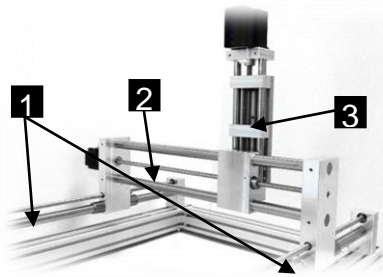

Figure 27: Trapezoidal threaded spindle

1. Switch off the machine and secure against re-start
2. Grease the Trapezoidal Thread Spindle of the X-axis (Fig. 27/1), the Y-axis (Fig. 27/2) and the Z-axis (Fig. 27/3) well using a low-friction grease wetted cloth DIN 61650 or alternatively apply the fat with a suitable brush.

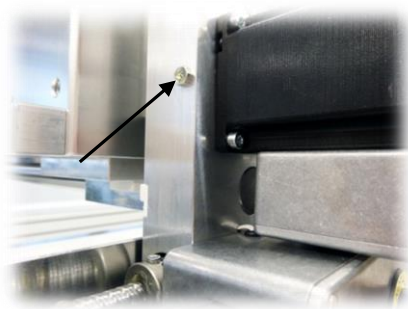

Figure 32: grease nipple Y-axis

- 7 Put Grease Gun onto the grease nipple on the Y-axis.
- 8 Press Grease Gun once or twice.
- 9 Remove grease gun.

### Grease nipples of the Z-axis (1 pc)

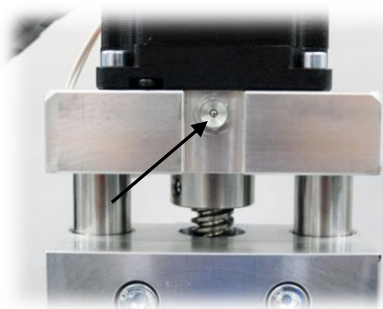

Figure 33: grease nipple Z-axis

- 10 Place Grease Gun onto the grease nipple on the Z-axis.
- 11 Press Grease Gun once or twice.
- 12 Remove Grease Gun.

## **8.5 Measures after maintenance**

After completion of maintenance and before turning on the machine, perform the following steps:

- 1 Check all previously loosened screw connections for tightness.
- 2 Verify that all previously removed protective devices and covers are reinstalled correctly.
- 3 Ensure that all tools, materials and other equipment used were removed from the work area.
- 4 Clean work area and remove any spilled substances such as fluids, processing material or similar materials.
- 5 Ensure that all safety devices on the machine function properly.



## 9 Failures

In the following chapter possible causes of interference are described and how to solve them. With increasingly occurring disorder shorten the maintenance intervals according to the actual load. For malfunctions that cannot be remedied by the following instructions, contact the manufacturer.

### 9.1 Cautions for Troubleshooting

#### Electrical System



**DANGER:**

**Danger to life due to electric current!**

Contact with live components can be fatal. Activated electrical components can run uncontrolled movements and cause serious injury.

- Before starting work, switch off electrical supply and secure against reconnection.

#### Moving components



**WARNING:**

**Danger of injury by moving parts!**

Rotating and / or linearly moving parts can cause severe injury.

- Before starting maintenance on movable components, turn off machine and secure against reconnection. Wait until all parts have come to a standstill.
- In hazardous area wear tight-fitting protective clothing with low tensile strength

## Improperly executed fault elimination



### **WARNING:**

#### **Risk of injuries caused by improper fault elimination!**

Improperly performed work and troubleshooting can cause serious injury and considerable damage to property.

- Before starting any work sufficient installation freedom has to be given
- Maintain order and cleanliness at the installation site! Loosely stacked or scattered components and tools are accident sources.
- • If components have been removed, ensure correct assembly, reinstall all fasteners and tighten with screw tightening torques.

Note the following before restarting:

- Ensure that all work and troubleshooting according to the information and instructions in this manual have been carried out and completed.
- Ensure that there are no persons in the danger zone.
- Ensure that all covers and safety devices are installed and working properly.

## Response to malfunctions

- 1 For malfunctions that constitute an immediate danger to persons or property, immediately initiate emergency stop
- 2 Determine cause of malfunction.
- 3 If the troubleshooting requires work in the danger area, turn off the machine and secure against reconnection. Inform responsible about disorder immediately
- 4 Depending on the type of disorder this can be eliminated by authorized personnel.



The fault table listed below provides information about who is entitled to eliminate the fault.

## 9.2 Diagnosis Chart

description of the error	Cause	Remedy	Personnel
Machine has no function	Emergency stop button has been pressed	Cancel the emergency stop	Operator
	Toggle Signal is missing	See pin assignment in software	qualified personnel
	Control cable broken	repair	Manufacturer
Stepper motor stands	Stepper motor (X, Y and / or Z-axis) is overloaded	Check connecting line if required, check control, see separate instructions of the controller.	qualified personnel
step loss	Stepper motor of the X-axis (X1 and / or X2) is overloaded	Check machine perpendicularity	qualified personnel
	Travel speed too high	Correct the setting in software	Operator
-the bridge is not at right angles to the X axis	Step losses, power failure, physical influence	(see chapter 9.3.2)	Operator
	Travel speed too high	Correct the setting in software	Operator
Angular deviation in the milling result	Y-the bridge is not at right angles to the X axis	(see chapter 9.3.2)	Operator
	Travel speed too high	Correct the setting in software	Operator
Cracking or loud noise when driving the axes	PCI-interface/Parallel port is defective	Stop the operation and contact manufacturers	manufacturer
	Lack of maintenance	Lubricate spindle waves	Operator
Hard lock error occurred	USB dongle was not found (WIN PC-NC Economy)	Check the USB dongle for proper connection	Operator

<b>description of the error</b>	<b>Cause</b>	<b>Remedy</b>	<b>Personnel</b>
Real-time module is blocked	On Windows, other programs are still running in the background	Close programs in the background of Windows	Operator
	Energy saving mode for the USB port is active	Disable power saving mode in the BIOS	qualified personnel
Machine travels a short distance and stops abruptly	USB dongle is not inserted properly or not at all	Check the USB dongle for correct fit	Operator
Machine jammed and cannot be moved	Lack of care and maintenance	Clean, re-lubricate if necessary repair by manufacturer	Operator / manufacturer
Machine does not recognize the reference switch	Feed homing in software incorrectly set	Set guideline 5mm/sec in software	qualified personnel
	Reference switch is defective	Replacement or repair	Personnel / Manufacturer
Increased backlash	Worn Nylatronnut achieved by lack of maintenance or reached service life	Replacement or repair	manufacturer
	Trapezoidal spindle worn by lack of maintenance	Replacement or repair	manufacturer



If a disorder in the fault table is not included, please contact Customer Service. See the separate operating instructions regarding the correcting of fault of the supplied components.



## 9.3 Problem resolution

### 9.3.1 Cancel the emergency stop

Personnel: • Operator

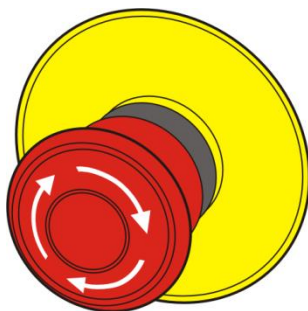

Figure 34: Emergency stop button

- 1 Determine and remedy the fault cause.
- 2 Unlock the emergency stop button by turning (Fig. 34) twice.

### 9.3.2 Check axes for perpendicularity

Personnel: • Qualified personnel

Safety equipment: • protective clothing

• Safety shoes

- 1 Check the Y-axis to the X axis on squareness, where necessary, re-align using the operation description for aligning the machine regarding perpendicularity (see chapter 9.3.3)
- 2 Start reference run with zero-point approach; see separate instructions of the software.



---

### 9.3.3 Description of process for aligning the machine with respect to perpendicularity

**Requirements: A complete structure of the portal system, including controller, PC and software.**

Using the control software of the machine (X-axis) drive against the movable bearing brackets of the X-axis (see chapter 4.1) by manual, slow speed and stop for a short time(max. 5 mm / s). Thereby the two stepper motor drives of the X-axis are synchronized, and the Y-bridge with the X-axis is aligned at right angles. After this procedure, retract the Y-Bridge by about 30mm from the stop blocks (depending on the position of the magnet holder of the X-axis) and then initiate a reference run. The machine is ready for operation.



**HINT:**

**Property damage caused by non-observance of perpendicularity!**

Ignoring the perpendicularity can cause considerable damage to the mechanics.



**HINT:**

If in doubt please contact the customer service "customer service" on page 7.

### 9.4 Commissioning after fault has been rectified

Perform the following steps to restart after correcting the fault:

- 1 Reset the emergency stop devices.
- 2 Acknowledge the fault of the control.
- 3 Make sure, that nobody is sure no persons in the danger zone.
- 4 Start according to the instructions in chapter "Operation".



## 10 Dismantling and disposal

Once the maximum lifetime of the machine is reached, the machine must be dismantled and environmentally friendly disposed.

- Disassembly should only be performed by qualified personnel.
- Work on the electrical system may only be performed by qualified electricians.

### 10.1 Safety regulations for the disassembling and disposal

#### Improper disassembling



**WARNING:**

**Risk of injury from incorrect disassembly!**

Residual stored energies, angular components, peaks and corners on or in the machine or on the required tools can cause injury.

- Before starting any work ensure sufficient space.
- Take care with sharp-edged components.
- Maintain order and cleanliness in the workplace! Loosely stacked or scattered components and tools are accident sources.
- Disassemble components professionally. Note partially high weight of the components. If necessary, use lifting equipment.
- Secure components so they do not fall down or fall over.
- If in doubt consult the manufacturer

### 10.2 Disassembling

Before beginning with dismantling:

- Switch off the machine and secure against restart.
- Discharge all power supply from the machine, physically separate stored residual energy.
- Remove the operating and auxiliary materials and residual processing materials and dispose environmentally friendly.

Then clean modules and components in a professional manner and in accordance with applicable local safety and environmental regulations.

### 10.3 Disposal

If no return or disposal agreement has been made, select dissected components for recycling:

- Scrap metals.
- Plastic items for recycling.
- Other components dispose sorted by material nature.



**HINT:**

Threat to the environment due to improper disposal!

Incorrect disposal may cause environmental hazards may.

- electrical scrap, electronic components, disposal of lubricants and other excipients must be carried out by authorized companies.
- If in doubt obtain information on environmentally responsible disposal at the local municipal authority or specialized disposal companies.

## **11 Appendix**

### **11.1 Accessories**

For the machine, there is a wide variety of applications.

Here is an excerpt from our catalogue of comprehensive range of accessories:

#### **Machine extensions**

- Enclosures, sub-racks, power arms,
- T-slot plates, T-slot plates on head frame

#### **Work holding**

- Vacuum tables and pumps, clamps, nuts

#### **Tools milling, engraving, drilling**

- Spindles, tool change spindles, collets, etc.
- Cutter for many different applications and materials, engraving, drill
- Axes of rotation and jaw chuck, depth sensor, tool length sensor, suction, minimum quantity lubrication etc.

#### **Tools for various applications**

- Tangential cutting (oscillating or fixed)
- grooving module
- Laser engraving unit
- Laser scanning unit
- Plasma torch
- GranitoGrav (module for stone engraving)

#### **Hardware and Software**

- PC's and Monitors
- Radio remote control
- CAD / CAM software, font packs, specialized software

If interested, please contact our Customer Service by email or phone.

We will be pleased to advise you and give you an exact offer for your requirements!

Numerous suggestions and information is also available on our website.

## 12 Customer Service

For technical information, please contact our Technical Customer Service:

Address:	CNC-STEP e.K. Siemensstraße 13-15 D-47608 Geldern	
Phone:	+49 (0)2831/91021-50	(Mo. - Fr. 07.00 - 15.00 Uhr)
Mobile:	+49 152 22345755 Only in urgent cases	(Mo. - Do. 15.30 - 18.00 Uhr)
Fax:	+49 (0)2831/91021-99	
E-Mail:	support@cnc-step.de	
Web:	<b><i>www.cnc-router.com</i></b>	

If you have questions, please contact our customer service via e-mail or phone.  
We advise you gladly.

Numerous suggestions and information can be found on our website:

***www.cnc-router.com***